

FOR\_KOMPONENT\_DIMENSJONER\_SE:93529

No. Unit		Pos. No.		Name, type, dim.		Drawing no. Standard		Art. No.		Matr. Spec.	
Date		Drawn		Projection		Scale				Replaces: Replaced by:	
23.03.07		T. I. Engen									
Checked		Appr.						ART.NR.: 100262		342170 Side:	

Lyn-out: 1000/1000

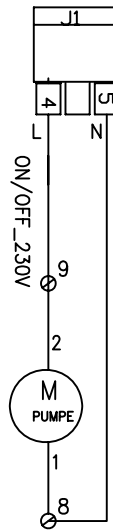

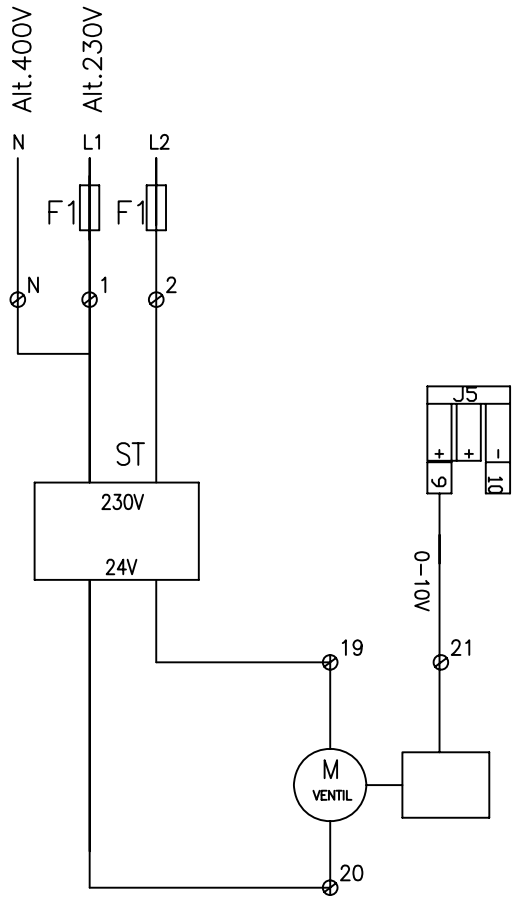









Changes		Date/Sign.		No. Unit		Pos. No.		Name, type, dim.		Drawing no. Standard		Art. No.		Matr. Spec.	
Date		08.05.07		Drawn		T. I. Engen		Projection		Scale		Replaces:		Replaced by:	
Checked				Appr.											
KOBLING VANNBATTERI												342152		Side:	
CS 500 230V/400V															
ART.NR.: 100033															

## TILKOBLING TERMINAL OG KOMPONENTER

CS500 IO	Funksjon	IO Type	Tilkobling CS500	Tilkobling komponenter
<b>J1</b>				
J1	PE	Digital	J1(Pin1)	
J1	Hovedtilførsel	Digital (230V)	J1(Pin2,3)	
J1	Pumpe (vannbatteri)/ Varme trinn 2 (el.batteri)	Digital (230V 11A)	J1 (Pin 4,5)	X:9, X:8 (bare ved vannbat)
J1	Ikke i bruk	Digital	J1 (Pin 6,7)	
J1	Ute spjeld (Pin8=L ON/OFF Pin9=L Pin10=N)	Digital (230V 2A)	J1 (Pin 8,9,10)	X:6, X:7,X:5
J1	Ikke I bruk		J1 (Pin 11-16)	
<b>J2</b>				
J2	Ikke i bruk			
<b>J3</b>				
J3	Alarm utgang prioritet A	Digital	J3 (Pin 1,4)	X:18, X:16
J3	Alarm utgang prioritet B	Digital	J3 (Pin 2,4)	X:17, X:16
J3	Ikke i bruk		J3 (pin 5)	
J3	Kjøling DX trinn1	Digital	J3 (Pin 6,8)	X:14, X:13
J3	Kjøling DX trinn2	Digital	J3 (Pin 7,8)	X:15, X:13
<b>J4</b>				
J4	Hastighet 1	Digital	J4(Pin 1,G0)	
J4	Hastighet 2	Digital	J4(Pin 2,G0)	
J4	Alarm eksternt brann/røyk	Digital	J4 (Pin 3,G0)	X:29, X:30
J4	Varme av/på. Eksternt signal	Digital	J4 (Pin 4,G0)	
J4	Temperaturinnstilling. Eksternt signal	Analog (0 - 10V)	J4 (Pin 5,6)	
J4	Temperaturavlesning tilluft	Analog (0 - 10V)	J4 (Pin 7,G0)	
J4	Temperaturavlesning avtrekk	Analog (0 - 10V)	J4 (Pin 8,G0)	
J4	Temperaturavlesning Uteluft	Analog (0 - 10V)	J4 (Pin 9,G0)	
J4	Avtrekk/rom temperatur	NTC	J4 (Pin 11)	X:25, X:26
J4	Utetemperatur	NTC	J4 (Pin 13)	X:27, X:28
J4	Eksternt trykksensor tilluft	Analog (0 - 10 V)	J4 (Pin 14,G0)	X:35, 36
J4	Eksternt trykksensor avtrekk	Analog (0 - 10 V)	J4(Pin 16,G0)	X:33, 34
<b>J5</b>				
J5	Tilluftstemperatur sensor	NTC	J5 (Pin 1,G0)	X:23, X:24
J5	Frost/is sensor vannbatteri	NTC	J5(Pin3,4)	Temperatur sensor B5
J5	Termostat man. reset el.batteri	Digital	J5(Pin5,8)	Termostat F10
J5	Ikke I bruk		J5(Pin 6,7)	
J5	Ettervarme full range vannbatteri	Analog (0 - 10V)	J5(Pin 9)	X:21, X:22
J5	Rotor	Analog (0 - 10 V)	J5(Pin 11)	P10X:33), G0
J5	Rotor: Rotor alarm	Digital	J5(Pin 13,14)	P10X:43,P10X:42
J5	Eksternt start/stopp	Digital	J5(Pin 15,G0)	
J5	Forsert drift. Hastighet 3	Digital	J5(Pin 16,G0)	X:31, X:32
<b>J6</b>				
J6	Tilluftsvifte.	Analog (0 - 10 V)	J6 (Pin 1,3)	VifteTil X:4, G0
J6	Start/stopp tilluftsvifte	Digital	J6 (Pin 2,G0)	
J6	Alarm vifte tilluft/avtrekk	Digital	J6 (Pin4,6)	VifteAvtX:NO,VifteTilX:NO
J6	Spenningsforsyning 12V	Analog (12VDC)	J6(Pin5)	X:SSR1-2A1
J6	Avtrekksvifte.	Analog (0 - 10 V)	J6 (Pin 7)	VifteAvtr X:4, G0
J6	Start/stopp avtrektsvifte	Digital	J6 (Pin 8,G0)	
J6	Filtervakt tilluft	Digital	J6(Pin 10,G0)	Filtervakt P1, G0
J6	Filtervakt avtrekk	Digital	J6(Pin 12,G0)	Filtervakt P2, G0
J6	Puls med Modulering (ON/OFF)	Analog	J6 (Pin 13)	X:SSR1-2 A1
J6	Kjøling	Analog (0 - 10V)	J6 (Pin 15,16)	X:37, X:38

Farge kode interne ledninger Colour code - Internal wiring					
L1 1~ (N)	230V	Blå (lys)	Blue (light)	BU	
L2 1~	230V	Svart	Black	BK	
24V AC (G)	Led 1 +	Rød	Red	RD	
Zero (0-point) G0	Led 2 -	Hvit	White	WH	
24V DC	Led 1 +	Blå (mørk)	Blue (dark)	BU	
Zero (0-point) G0	Led 2 -	Hvit	White	WH	
0-10V DC		Grå	Grey	GY	
Pot.free signal		Grå	Grey	GY	
G0 (0-point) from trafo 24V -					

# Elkomponentoversikt CS1000

93529/2008-01

Type	F1	F2	F3	F4	K1	K2	SSR	EB/stk	Tot kW
L20 XE 230 V	2*16	2*16	3*50		3*45		50	2500W	15kW
L20 XE 400 V	2*16	3*25			3*25		50	2500W	15kW
L20 XW 230 V	2*10	2*10							
L30 XE 230 V	2*16	2*16	3*32	3*32	3*32	3*32	50	3333W	20kW
L30 XE 400 V	2*16	3*32			3*25	3*25	50	3333W	20kW
L30 XW 230 V	2*10	2*10							
S20/30 E 230 V	2*16	2*16	3*50		3*45		50	2000/2500W	12/15kW
S20/30 E 400 V	2*16	3*25			3*45		50	2000/2500W	12/15kW
S20/30 W 230 V	2*16	2*16							
S20/30 W 400 V	2*16								
L14 RE 230V	2*10		3*10		3*25		25	1200W	3,6kW
L14 RE 400V	1*10		3*10		3*25		25	1200W	3,6kW
L14 RE 230V	2*10		3*10		3*25		25	600W	1,8kW
L14 RE 400V	1*10		3*10		3*25		25	600W	1,8kW
L14 RW 230V	2*10								
L20 RE 230V	2*10	2*10	3*16		3*25		25	2000W	6kW
L20 RE 400V	2*10	3*16			3*25		25	2000W	6kW
L20 RE 230V	2*10	2*10	3*16		3*25		25	1000W	3kW
L20 RE 400V	2*10	3*16			3*25		25	1000W	3kW
L20 RW 230V	2*10	2*10							
L20 RW 400V	2*10								
L40/30 RE 230V	2*16	2*16	3*32		3*45		75	2000W	12kW
L40/30 RE 400V	2*16	3*25			3*45		75	2000W	12kW
L40/30 RE 230V	2*16	2*16	3*25		3*45		75	2000W	6kW
L40/30 RE 400V	2*16	3*16			3*45		75	2000W	6kW
L40/30 RW 230V	2*16	2*16							
L40/30 RW 400V	2*16								
L50XE 230V	3*32	2*10	external	external	3*45	3*45	50	2833W	34kW
L50XE 400V	2*25	1*10	external	external	3*45	3*45	50	2833W	34kW
L50XW 230V	3*32	2*10							
L50XW 400V	2*25	1*10							
L60RE 230V	3*16	3*16	3*50		3*45		75	2500W	15kW
L60RE 400V	3*16	3*16	3*25		3*45		75	2500W	15kW
L60RE 230V	3*16	3*16	3*25		3*45		75	2500W	7,5kW
L60RE 400V	3*16	3*16	3*16		3*45		75	2500W	7,5kW
L60RW 230V	3*16	3*16							
L60RW 400V	3*16	3*16							

## Elkomponentoversikt CS500

Type	F1	F2	F3	F4	K1	K2	SSR	EB/stk	Tot kW
S12XE 230V	2*10		external		3*20		25	2000W	6kW
S12XE 400V	1*10		external		3*20		25	2000W	6kW
S12XW 230V	2*10								
S12RE 230V	2*10		external		3*20		25	2000W	6kW
S12RE 400V	1*10		external		3*20		25	2000W	6kW
S12RW 230V	2*10								
L14 RE 230V	2*10		3*10		3*25		25	1200W	3,6kW
L14 RE 400V	1*10		3*10		3*25		25	1200W	3,6kW
L14 RE 230V	2*10		3*10		3*25		25	600W	1,8kW
L14 RE 400V	1*10		3*10		3*25		25	600W	1,8kW
L14 RW 230V	2*10								
L20 RE 230V	2*10	2*10	3*16		3*25		25	2000W	6kW
L20 RE 400V	2*10		3*16		3*25		25	2000W	6kW
L20 RE 230V	2*10	2*10	3*16		3*25		25	1000W	3kW
L20 RE 400V	2*10		3*16		3*25		25	1000W	3kW
L20 RW 230V	2*10	2*10							
L20 RW 400V	2*10								
L40/30 RE 230V	2*16	2*16	3*32		3*45		75	2000W	12kW
L40/30 RE 400V	2*16		3*25		3*45		75	2000W	12kW
L40/30 RE 230V	2*16	2*16	3*25		3*45		75	2000W	6kW
L40/30 RE 400V	2*16		3*16		3*45		75	2000W	6kW
L40/30 RW 230V	2*16	2*16							
L40/30 RW 400V	2*16								
L60RE 230V	3*16	3*16	3*50		3*45		75	2500W	15kW
L60RE 400V	3*16	3*16	3*25		3*45		75	2500W	15kW
L60RE 230V	3*16	3*16	3*25		3*45		75	2500W	7,5kW
L60RE 400V	3*16	3*16	3*16		3*45		75	2500W	7,5kW
L60RW 230V	3*16	3*16							
L60RW 400V	3*16	3*16							